

Paket belajar minimum sistem microchip 16f877 dan pickit 2

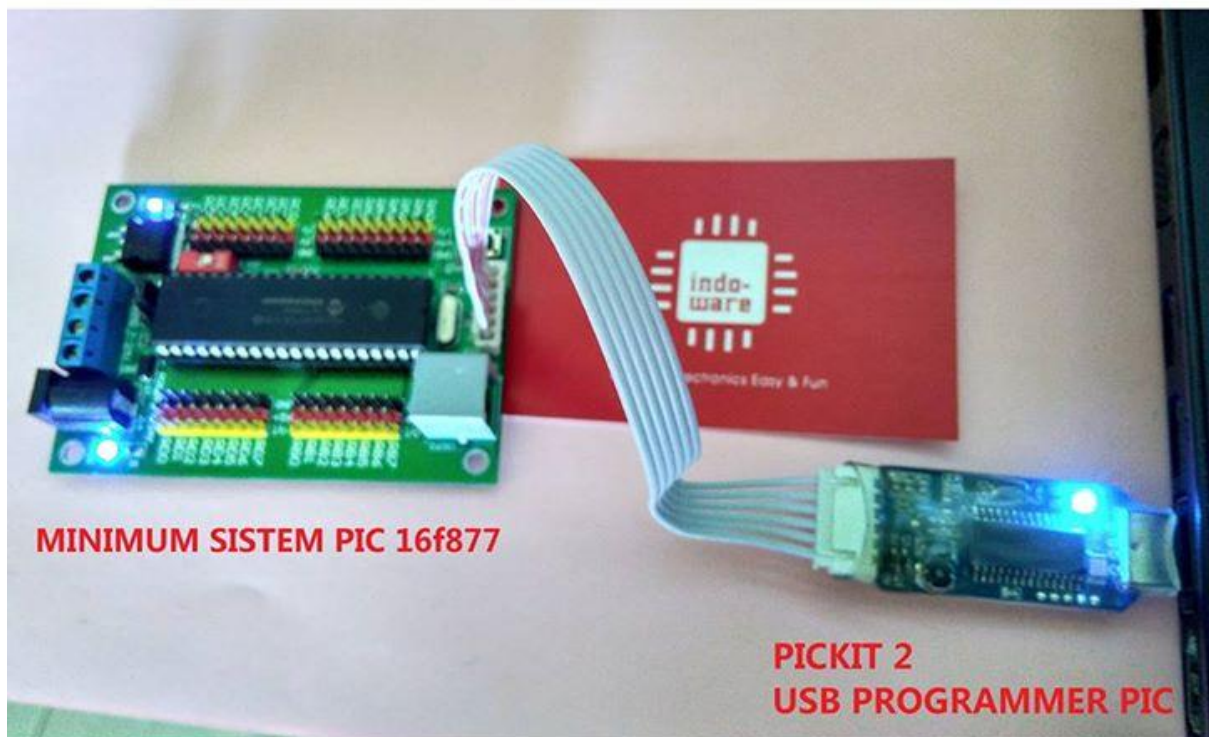

Paket belajar minimum sistem microchip 16f877 dan pickit 2

Detail produk.

Board PIC minimum sistem

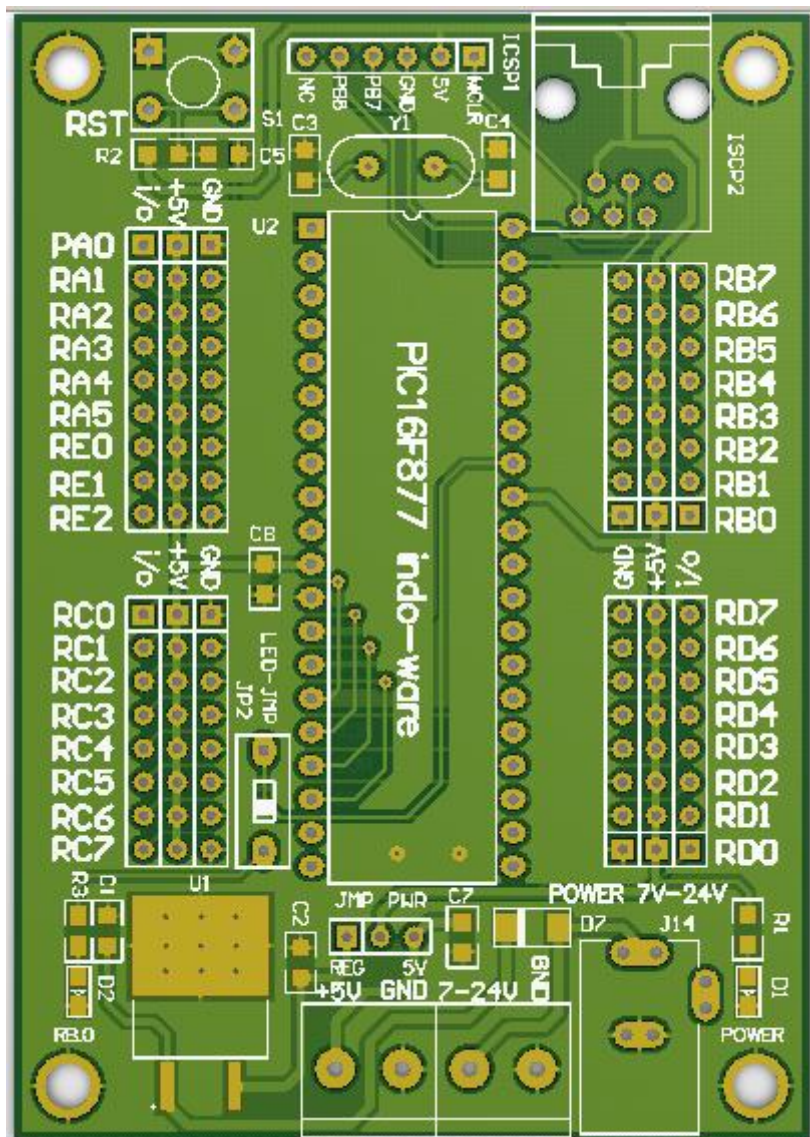

Paket belajar minimum sistem microchip 16f877 dan pickit 2

Board PIC minimum sistem

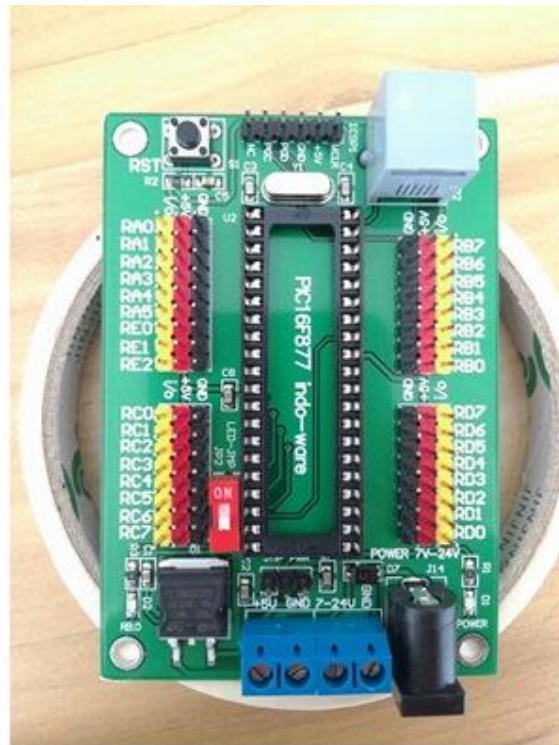

Board PIC minimum system:

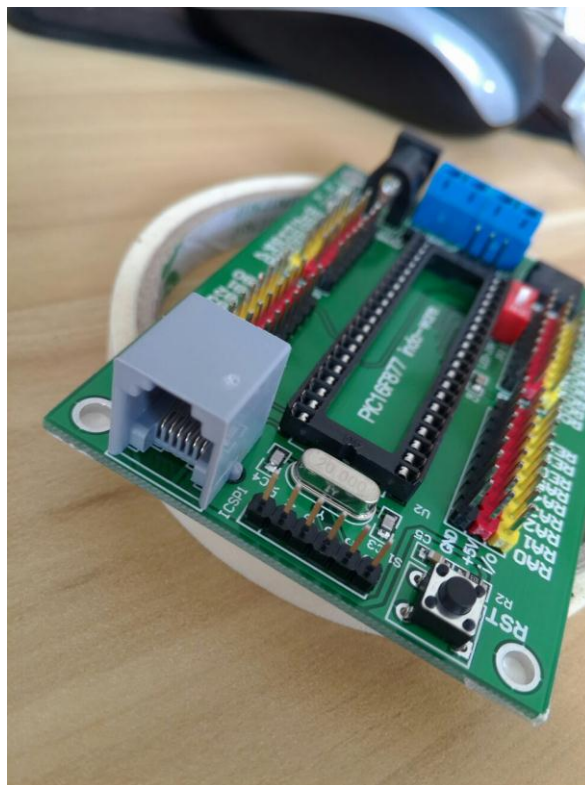

Paket belajar minimum sistem microchip 16f877 dan pickit 2

Detail programmer:

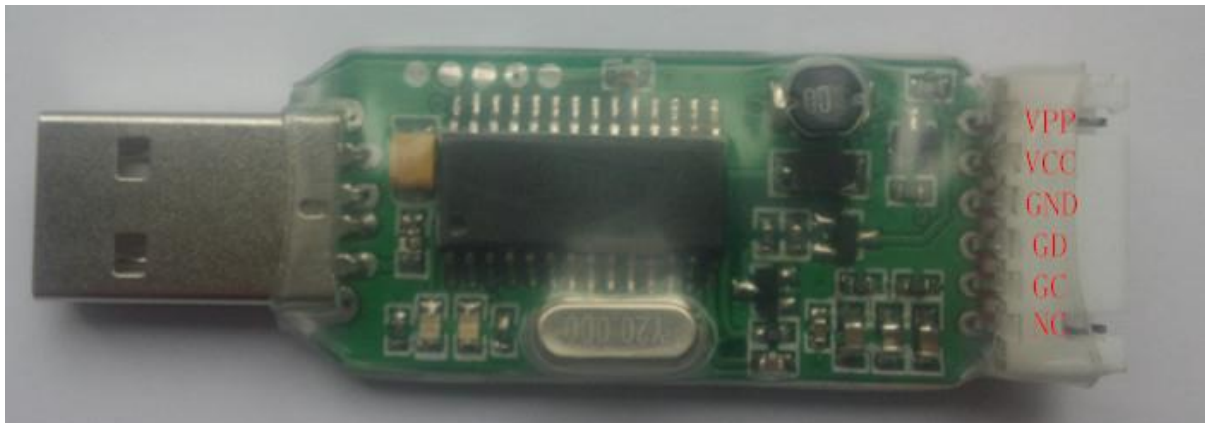

Detail interface programmer pickit2:

PICkit 2 Programmer - OlHoss

File Device Family Programmer Tools View Help

Midrange/Standard Configuration

Device: PIC16F877A Configuration: 2F4A

User IDs: FF FF FF FF

Checksum: 137E OSCCAL: BandGap:

Programming Successful.

MICROCHIP

VDD Target
 Check /MCLR 5.0

Read Write Verify Erase Blank Check

Program Memory

Enabled Hex Only Source: Read from PIC16F877A

0000	2804	3FFF	3FFF	3FFF	1303	1683	0186	30FF
0008	1283	0086	0986	3003	00FC	30FF	00FB	30FF
0010	00FA	0BFC	2814	281B	0BFB	2817	281A	0BFA
0018	2817	2814	2811	308C	00FB	30FF	00FA	0BFB
0020	2822	2825	0BFA	2822	281F	30A1	00FA	0BFA
0028	2827	0000	280A	282B	3FFF	3FFF	3FFF	3FFF
0030	3FFF	3FFF	3FFF	3FFF	3FFF	3FFF	3FFF	3FFF
0038	3FFF	3FFF	3FFF	3FFF	3FFF	3FFF	3FFF	3FFF
0040	3FFF	3FFF	3FFF	3FFF	3FFF	3FFF	3FFF	3FFF
0048	3FFF	3FFF	3FFF	3FFF	3FFF	3FFF	3FFF	3FFF
0050	3FFF	3FFF	3FFF	3FFF	3FFF	3FFF	3FFF	3FFF
0058	3FFF	3FFF	3FFF	3FFF	3FFF	3FFF	3FFF	3FFF

EEPROM Data

Enabled Hex Only

00	FF	FF	FF	FF	FF	FF	FF	FF	FF	FF	FF	FF	FF	FF	FF
10	FF	FF	FF	FF	FF	FF	FF	FF	FF	FF	FF	FF	FF	FF	FF
20	FF	FF	FF	FF	FF	FF	FF	FF	FF	FF	FF	FF	FF	FF	FF
30	FF	FF	FF	FF	FF	FF	FF	FF	FF	FF	FF	FF	FF	FF	FF

Auto Import Hex + Write Device

Read Device + Export Hex File

PICkit™ 2

Paket belajar minimum sistem microchip 16f877 dan pickit 2

Circuit Board PIC minimum sistem

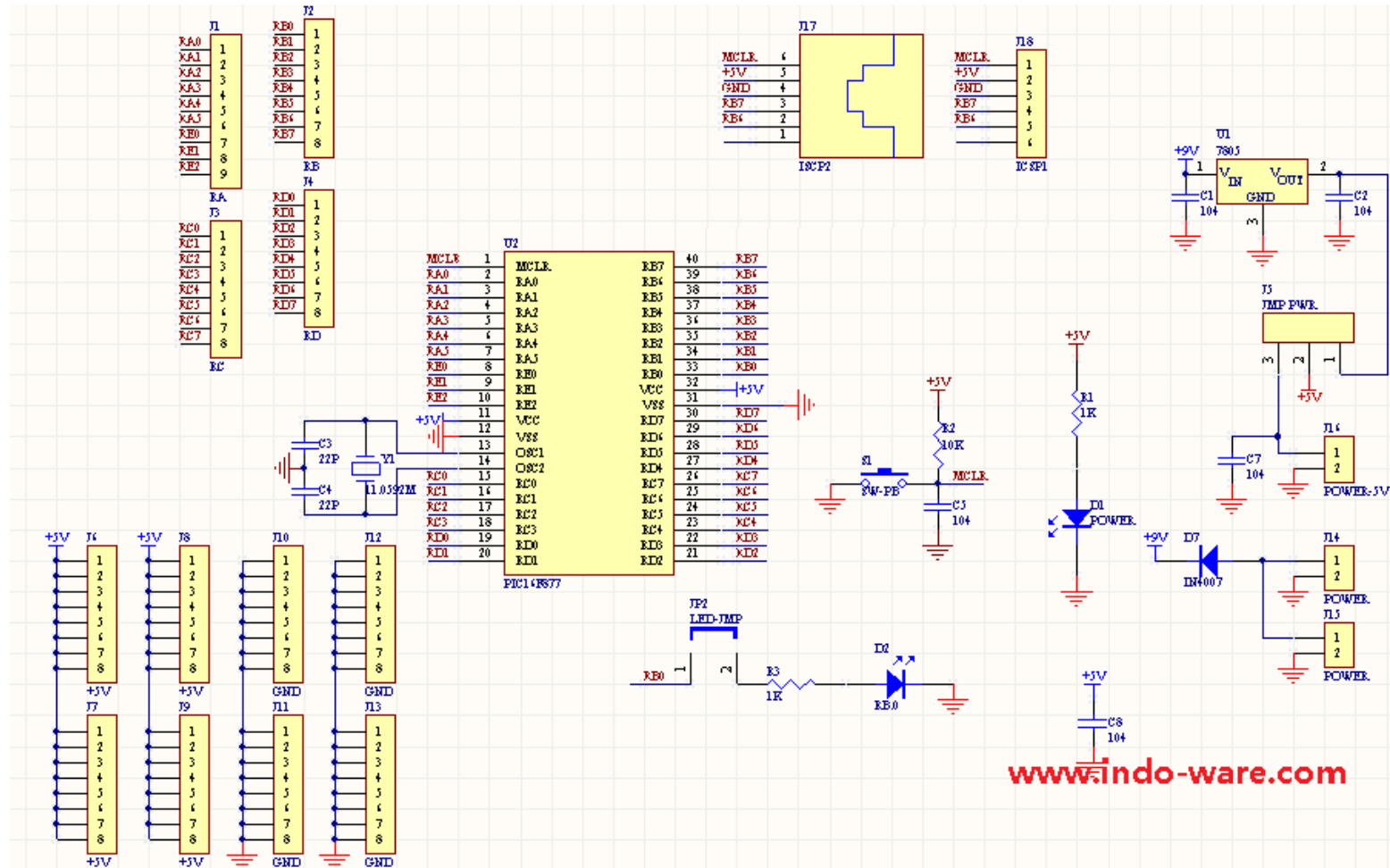

Paket belajar minimum sistem microchip 16f877 dan pickit 2

Pin 16f877 :

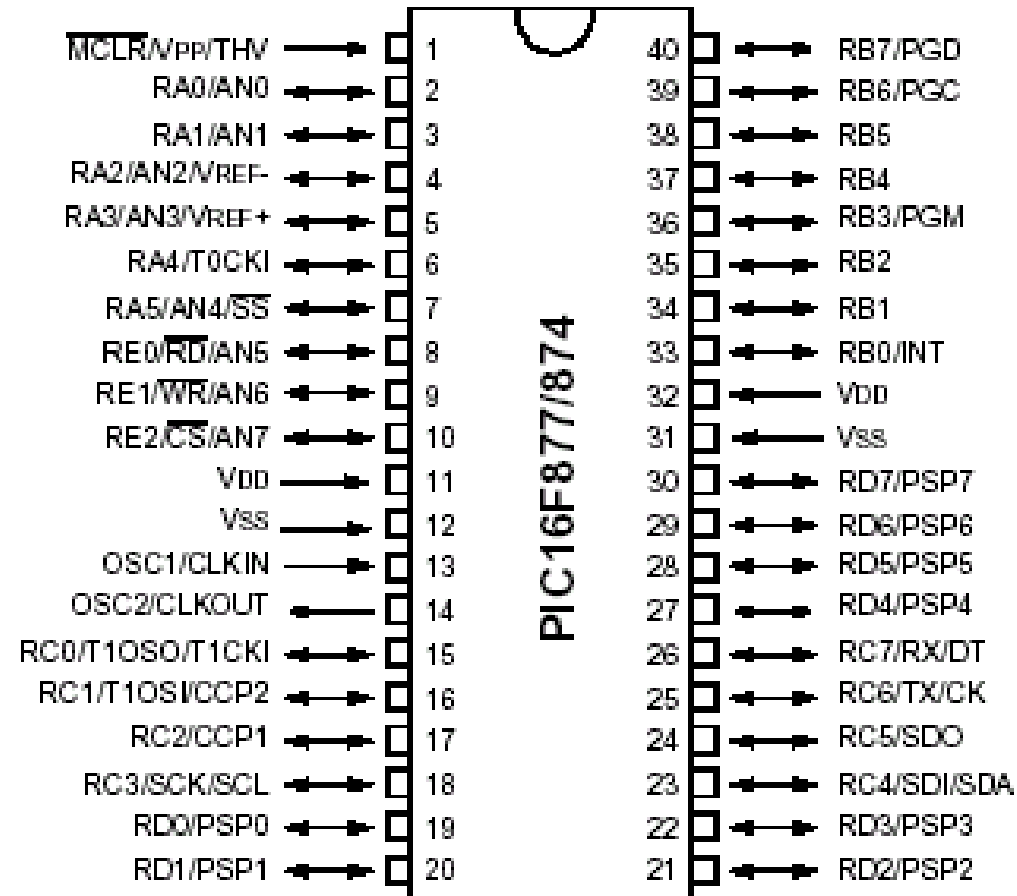

Paket belajar minimum sistem microchip 16f877 dan pickit 2

Paket Jual:

1 unit board minimum system pic 16f877 sudah termasuk chip 16f877

1 unit pic kit 2 dan kabel download 6 pin

1 unit cd software pickit2

Thanks

contact us:

www.indo-ware.com

sales email sales@indo-ware.com

support email support@indo-ware.com

telp 024 76637382 jam kerja 09 sd 17 wib, senin sd sabtu

Gambar Album ada di:

<https://www.facebook.com/media/set/?set=a.1038951849457430.1073742218.383734711645817&type=3&uploaded=3>